

ELAD DUO-ART 60

HF/50MHz 60W amplifier



USER MANUAL

Contents

Revision History	3
Supplied Accessories.....	3
1 Introduction	4
1.1 Notice.....	4
1.2 Precautions	4
1.3 Software and firmware versions.....	4
1.4 Features	4
1.5 Block Diagram	5
2 Panels Description.....	6
2.1 Front Panel Description	6
2.2 Rear Panel Description.....	7
3 User Interface	9
3.1 Menu Bar and Push-buttons	9
3.2 Main Window.....	10
3.2.1 Overview	10
3.2.2 Main Menu.....	11
3.2.3 Views	12
3.2.4 Tune Menu	14
3.2.5 Setting Menu.....	17
3.2.6 Messages.....	25
3.3 Memory Bank Window	28
3.4 Information Window.....	31
Annex A - Technical Specifications.....	32
Annex B - DUO-ART 60 Connections	34
FDMDUO Interface - Local Setup	34
FDMDUO Interface - Remote Setup.....	34
Generic Interface	35
FT-817 Interface.....	35
Annex C - Tune-up Procedure	36
Foreword.....	36
Warning.....	36
With the FDM-DUO Transceiver	37
With a Generic Transceiver	37
Product Warranty	38
Declaration of Conformity (EC)	39
FCC Certification.....	40

Revision History

Revision	Date	Description
Rev 1.0	03/2018	<ul style="list-style-type: none"> • First version.
Rev 1.1	04/2018	<ul style="list-style-type: none"> • Added section Messages.
Rev 1.2	04/2018	<ul style="list-style-type: none"> • Updated section 1.4 Features.
Rev 1.3	04/2018	<ul style="list-style-type: none"> • Added Annex A - Technical Specifications. • Updated pictures.
Rev 1.4	05/2018	<ul style="list-style-type: none"> • Added Annex B - DUO-ART 60 Connections.
Rev 1.5	07/2018	<ul style="list-style-type: none"> • Added Supplied Accessories. • Added section 1.5 Block Diagram. • Updated section 2 Panels Description. • Updated section 3 User Interface. • Updated Annex B - DUO-ART 60 Connections. • Added Annex C - Tune-up Procedure.
Rev 1.6	08/2018	<ul style="list-style-type: none"> • Updated section 1.3 Software and firmware versions. • Updated the menu items table under section 3.2.5 Setting Menu.
Rev 1.7	02/2020	<ul style="list-style-type: none"> • Various minor fixes. • Added information about the Stand-By mode in section 3.2.2 Main Menu. • Updated section 3.2.4 Tune Menu. • Updated the menu items table, under section 3.2.5 Setting Menu. • Added the description of menu 2 (Rx Filters Setting) and 40 (Spectrum Settings) at the end of section 3.2.5 Setting Menu. • Added the description of the Auto Tune Low Pwr warning. • Updated section 3.3 Memory Bank Window. • Updated section 3.4 Information Window. • Updated FT-817 Interface. • Updated Annex C - Tune-up Procedure. • <u>Underlined</u> and bolded the clickable links within the document.
Rev 1.8	09/2020	<ul style="list-style-type: none"> • Fixed the menu items table, under section 3.2.5 Setting Menu. • Updated Annex A - Technical Specifications.

Supplied Accessories

- 1 LAN cable.
- 1 PTT cable (jack 3.5 mm).
- 1 EXT I/O cable (DB9 connector type).
- 1 power cord (US or Schuko version).
- 2 PL-259 cables (for FDM-DUO RX and RTX connections).
- 1 DC power cord (Powerpole to 2.1 mm jack) to power the FDM-DUO.
- 1 DC power cord (Powerpole to open wires).
- 1 user manual.

1 Introduction

1.1 Notice

Amateur radio regulations vary from country to country. Check local amateur radio regulations and requirements before operating the ELAD DUO-ART 60.

1.2 Precautions

- Connect the amplifier only to a power source described in this manual.
- Take care when plugging-in cables, avoid applying sideways pressure that might damage the connectors.
- Avoid operating in wet conditions.
- Leave an empty space of at least ten centimeters (10cm / 4in) on both sides of the amplifier to allow the fans to operate correctly.
- For better performance and safety, connect the amplifier to good earth ground using a short, heavy, braided cable.
- Ground all outdoor antennas for this amplifier using approved methods. Grounding helps protect against voltage surges caused by lightning. It also reduces the chance of build-up of static charge.

1.3 Software and firmware versions

The features described in this manual refers to the following versions :

User Interface software	Internal firmware
Version 1.70 - date 11/20/2019	Version 1.02 – date 06/28/2018

1.4 Features

The DUO-ART 60 is a 60 watt amplifier for HF and 50MHz frequency ranges. It includes the internal PA power supply, preselector filters, an antenna tuner (optional) and acts as remote controller for the FDM-DUO.

The DUO-ART 60 has three modes of operation that are called **interfaces** :

1. **FDMDUO** interface : this interface is used when operating with the FDM-DUO,
2. **Generic** interface : this interface is used when operating with another transceiver,
3. **FT-817** interface : this interface is used to read the frequency through the RS-232 port using the FT-817 CAT protocol.

The DUO-ART 60 has 20 memory banks and each one saves :

1. the interface used,
2. the attenuators setting,
3. the antenna used,
4. the use of the antenna tuner,
5. and other settings.

The USA version of the DUO-ART 60 has a security feature that prevents to amplify in the frequency band 26-28MHz. Any attempt to drive the amplifier in the 26-28MHz frequency band will result in 0dB gain from input to output of the amplifier.

1.5 Block Diagram

The block diagram below shows the possible paths of the RF signal.

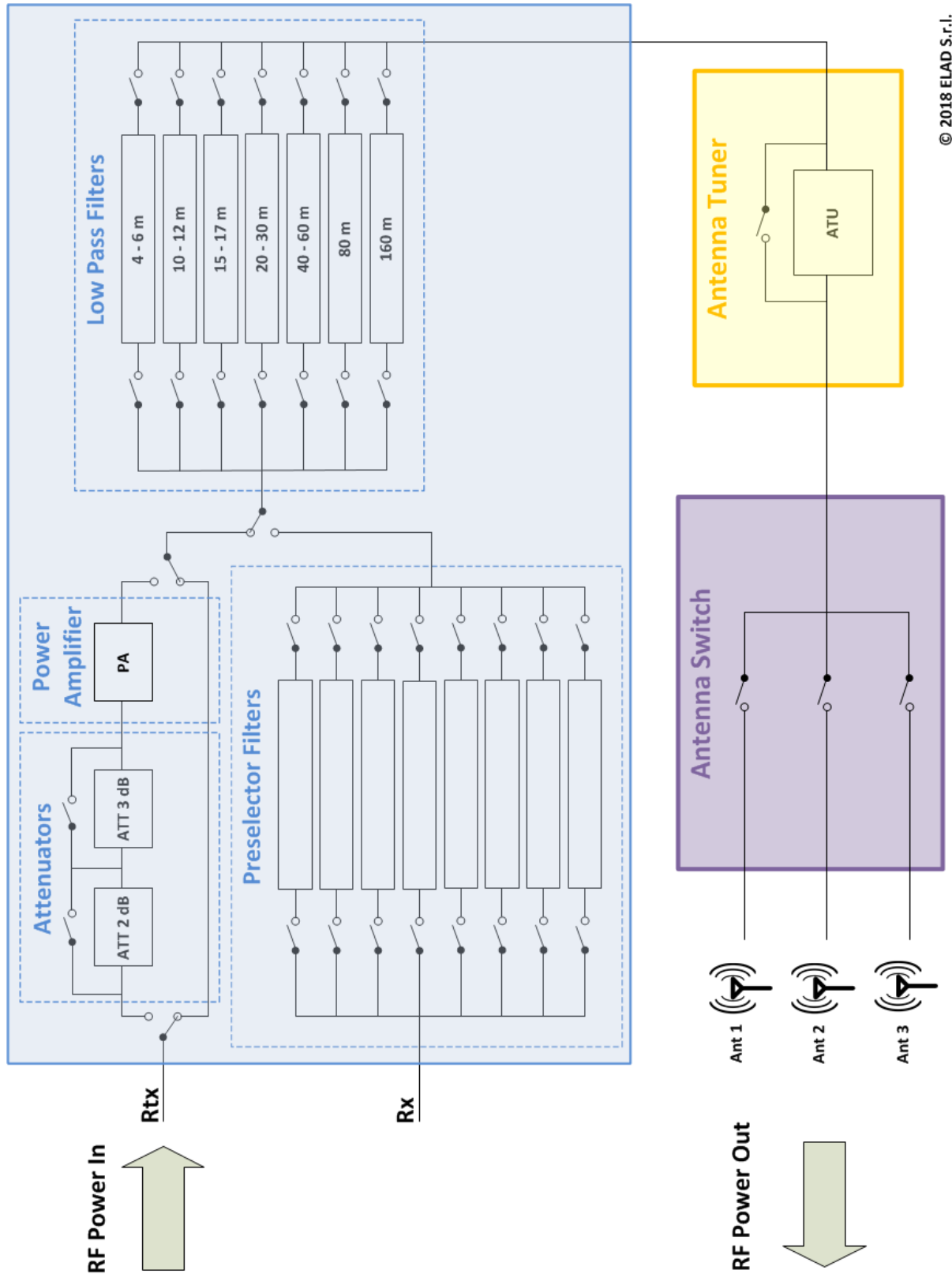

© 2018 ELAD S.r.l.

2 Panels Description

2.1 Front Panel Description

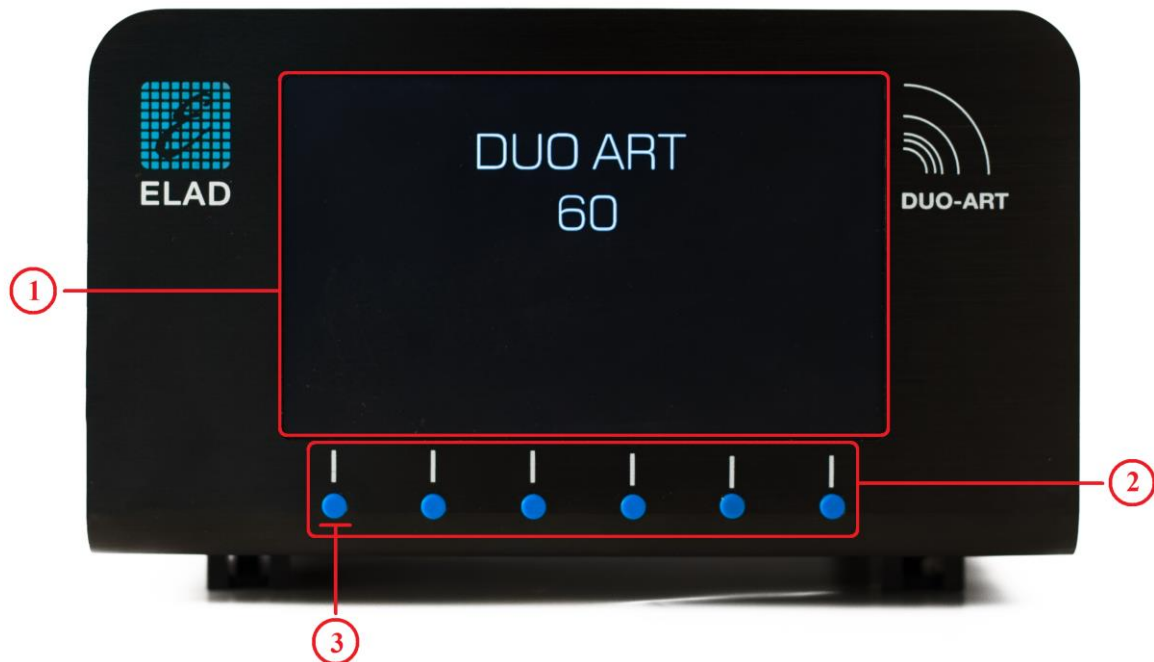

1 - Display

5.0 inches LCD TFT display with resolution of 800x480 pixels. Displays menus, power values and amplifier status.

2 - Push-buttons

These six **Push-buttons** allow to navigate in the menus and change the various working modes.

3 - Power button

To powered up the amplifier, first switch the main power switch on the rear panel, then press the first button on the left. When this button is released the amplifier emits an acoustic signal and in about ten to twenty seconds it will be ready to operate.

The menu **94 "Turn Off Hardware"** allows to put the DUO-ART 60 in **Low Power** mode, stopping both the software and the firmware. To shut down completely the DUO-ART 60 use the power switch situated on the rear panel.

2.2 Rear Panel Description

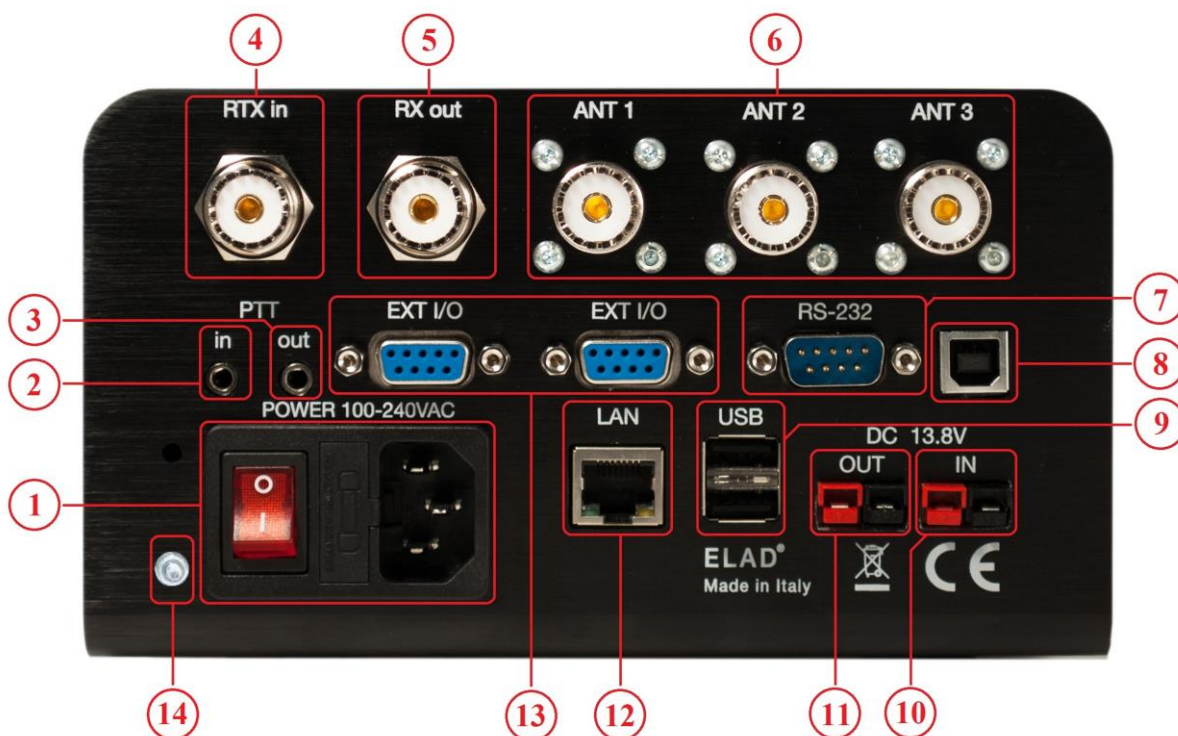

1 - Main power supply

Power switch, fuse holder and 100-240Vac power supply connector. Insert the power supply cable and use the power switch to power up the amplifier.

2/3 - PTT in/out

3.5mm jack connectors.

PTT in	Input for transmit control, connect TIP to ground to put the amplifier in transmit state.	
PTT out	The TIP goes to ground while transmitting.	

RING connection is not used.

4 - RTX connection

SO-239 connector. Transmit path with the FDMDUO interface. Reception and transmit paths with the other interfaces (Generic and FT-817).

5 - RX connection

SO-239 connector. Reception path with the FDMDUO interface.

6 - Antennas

SO-239 connectors to connect up to three antennas.

7 - RS-232 port

DB9 connector for the FT-817 interface acting on an RS-232 serial link.

8 - AUX USB port

Reserved for service.

9 - USB connection

USB type A female connectors for host type connections.

10 - Secondary power supply

13.8Vdc secondary power supply connector. Powerpole connector type.

11 - Output power supply

Allows to power other devices without the need of other power units. Max 2A. Powerpole connector type.

12 - LAN connection

RJ45 connector for LAN connection.

13 - EXT I/O

EXT I/O connection with external hardware such the FDM-DUO.

14 - Ground Connector

For better performance and safety, connect it to an earth ground using a short and wide cable.

The DUO-ART 60 has two power sources, the **Main Power Supply ①** – AC type, 100-240Vac – and the **Secondary Power Supply ⑩** – DC type, 13.8Vdc. Both can be plug in at the same time.

The DUO-ART 60 switches to the **Secondary Power Supply ⑩** only if the **Main Power Supply ①** is not present.

3 User Interface

3.1 Menu Bar and Push-buttons

The **Menu Bar** is composed of six labels corresponding to the **Push-buttons**. It allows together with the **Push-buttons** to modify the settings and navigate in the menus; therefore, the labels of the **Menu Bar** change in function of the selected **Window** or **Menu**.

The picture below shows the **Menu Bar** with the **Push-buttons** when the **Main Window** is displayed.

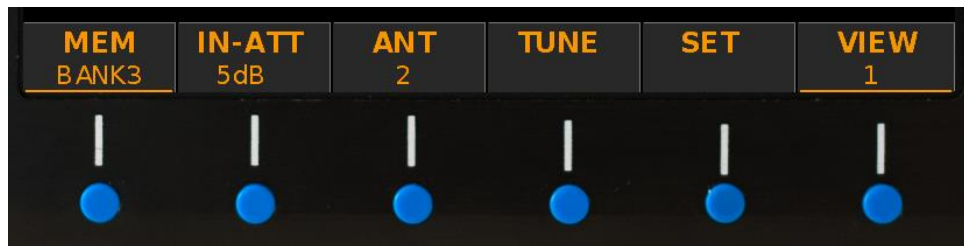

The **Push-buttons** have two type of press :

- a normal press,
- and a long press.

Long press is available when the label is underlined, as seen in the picture above for the **MEM** and **VIEW** labels. The settings menu **10 “Long Press Time”** allows to modify the long press duration.

Even if **Push-buttons** and labels are two separate things, this manual refers to a push-button using its label.

For example : “press the SET button” stands for “press the button under the SET label”.

3.2 Main Window

3.2.1 Overview

When the DUO-ART 60 is started the **Main Window** is displayed. This window is divided in six horizontal areas :

1. the top one shows the device name, the date, the hour and information about the LAN connection,
2. the second area shows a graph with the current transmission power and operating frequency, the **TX** label is displayed when the DUO-ART 60 is in transmission state,
3. the third area (text in blue) is a status bar that includes information about the current settings,
4. the fourth area (text in green) is a diagnostic bar that shows some diagnostic information,
5. the fifth area is used to show the **warning** and **error Messages**, some generic information (on the left) and the status of the antenna tuner (on the right),
6. the last area is the **Menu Bar** which is composed of six labels corresponding to the six **Push-buttons**.

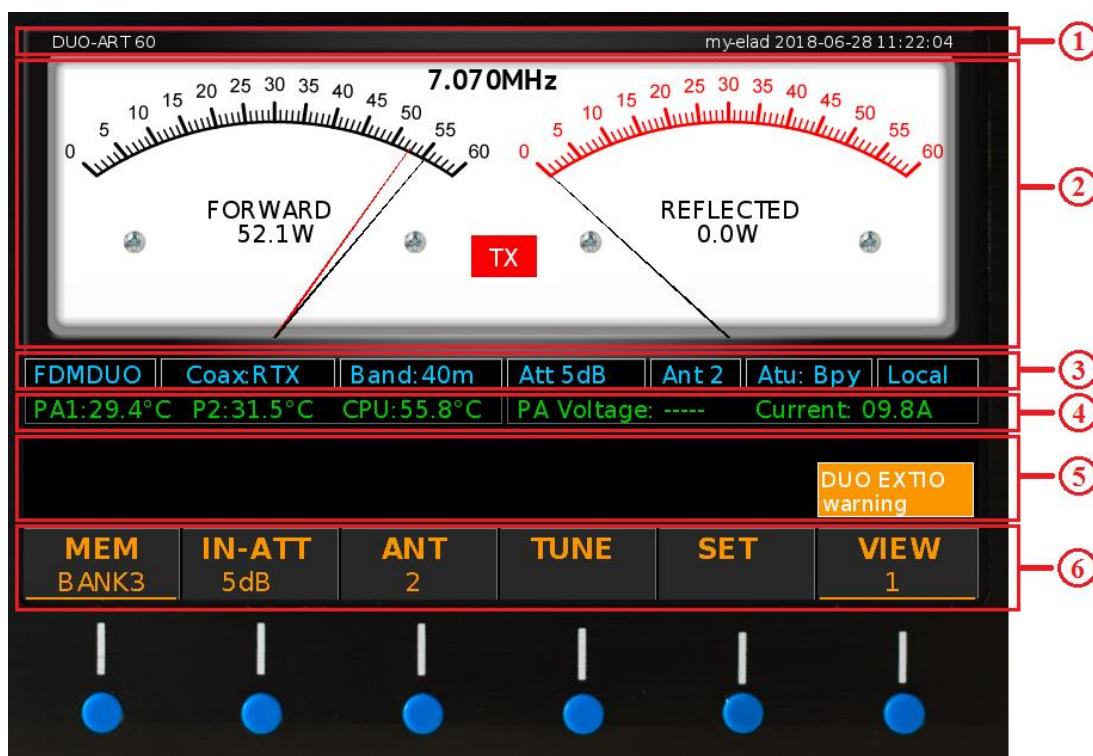

The menu 30 “Powers Unit” allows to choose the unit of measurement used to display the powers on the **Main Window**, Watt or dBm.

The menu 31 “Temperatures Unit” allows to choose the unit of measurement used to display the temperatures on the **Main Window**, Celsius or Fahrenheit.

3.2.2 Main Menu

The picture below shows the **Menu Bar** with the **Push-buttons** when the **Main Window** is displayed.

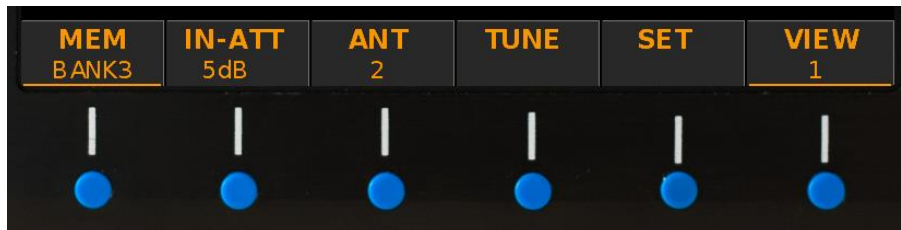

A normal press on the **Push-buttons** allows to perform the following operations :

- **MEM**: switch between the memory banks where the configurations are saved.
- **IN-ATT**: choose between the **Stand-By** mode and an **Input Attenuators** value (0, 2, 3 or 5 dB).
- **ANT**: choose the antenna connector used to operate.
- **TUNE**: allows to access to the **Tune Menu**.
- **SET**: allows to access to the **Setting Menu**.
- **VIEW**: switch between the different **Views**.

A long press on the **Push-buttons** allows to perform the following operations :

- **MEM**: allows to access to the **Memory Bank Window**.
- **VIEW**: allows to access to the **Information Window**.

The menu 1 “**Max Banks Number**” allows to modify the banks number in use until a maximum of 20 banks.

In **Stand-By** mode the internal PA (Power Amplifier) is not activated. The PA is activated when an attenuator value is chosen (0dB, 2dB, 3dB or 5 dB).

Refer to section **1.5 Block Diagram** to see where are the attenuators and the PA. The **Stand-By** mode allows bypassing attenuators and PA.

3.2.3 Views

While the **Main Window** is displayed, it is possible to switch the view with a normal press on the **VIEW** button. The number under indicates the selected view.

VIEW 1 : forward power and reflected power.

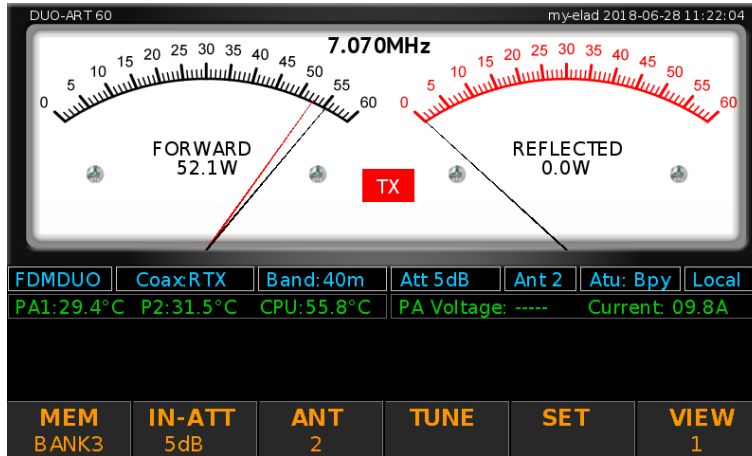

VIEW 2 : forward power and SWR.

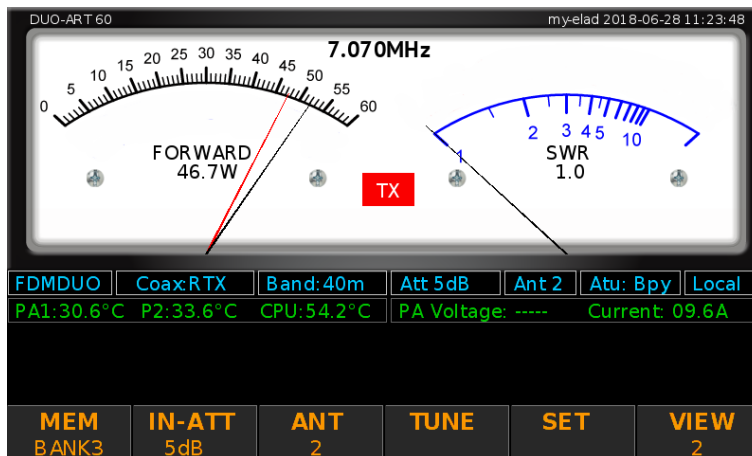

VIEW 3 : forward power and input power.

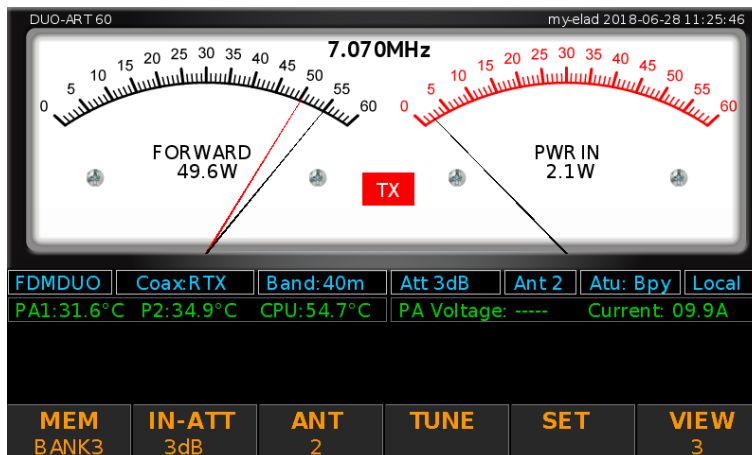

VIEW 4 : spectrum view.

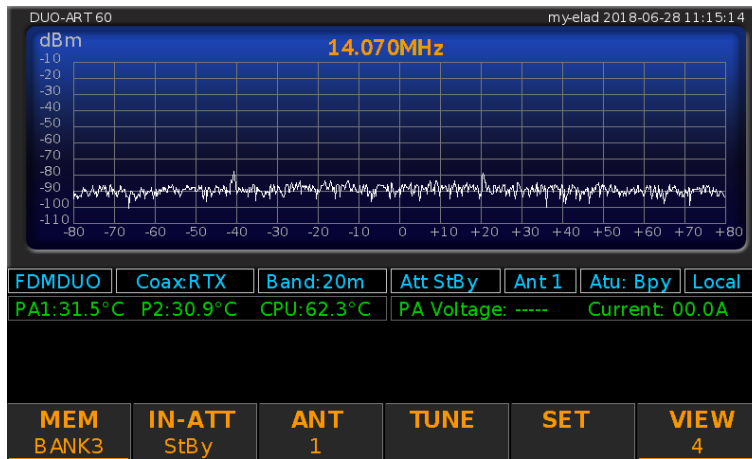

VIEW 5 : spectrum zoomed view.



Spectrum views are available only with the **FDMDUO** interface.

Menu **32 "View on TX"** allows you to choose which view to display during transmission.

3.2.4 Tune Menu

While the **Main Window** is displayed, it is possible to enter to the **Tune Menu** with a normal press on the **TUNE** button. The tune menu allows, if the ATU (automatic antenna tuner) is installed, to proceed to the **tune-up procedure**.

The picture below shows how changes the **Main Window** while the **Tune Menu** is displayed.

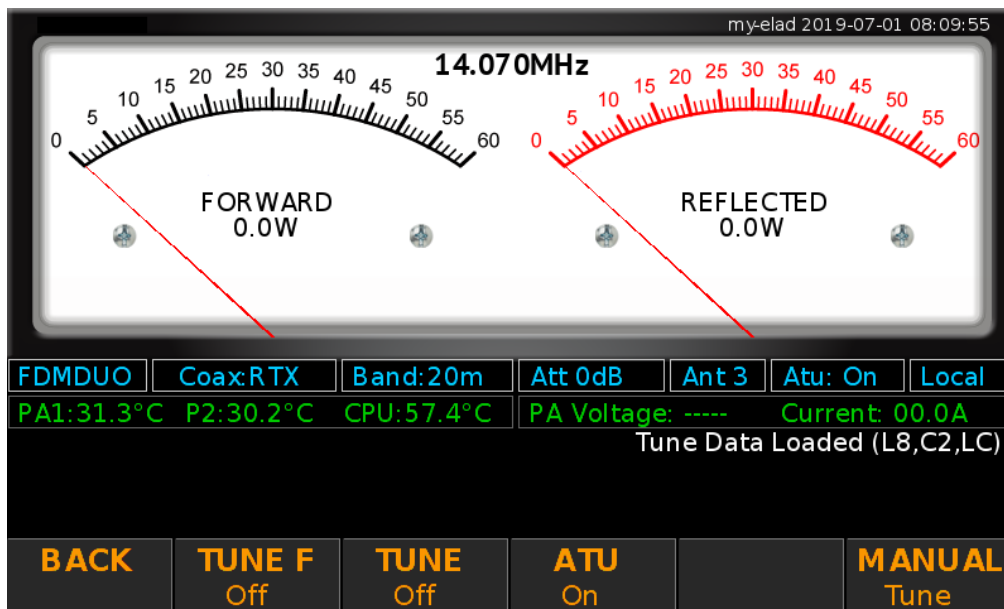

Button functionalities are the following :

- the **BACK** button allows to exit from the **Tune Menu**,
- the **ATU** button allows to enable and disable (to bypass) the ATU,
- the **TUNE** button allows to start the automatic tune-up which consists in carrying out a coarse tune-up followed by a fine tune-up, the ATU must be enabled with the **ATU** button in order to start the tune-up,
- the **TUNE F** button allows to proceed to a fine tune up, this operation is valid only if a manual tune-up has been carried out first,
- the **MANUAL Tune** button allows to access to the manual tune menu.

The ATU state is saved in the selected **Memory Bank**, this state can be **ON** or **ByPass**. Tune-up results are store in base of the selected bank and antenna.

To start the tune-up use the **TUNE** button. The DUO-ART 60 will first start a coarse tune-up and after finding the best point it will perform an accurate tune-up.

When a tune-up is successful, the DUO-ART 60 saves the tuning data relating to :

- **the selected memory bank**,
- **the selected antenna**,
- **the reference frequency**.

This tuning data are automatically reloaded when the same working conditions occur again : same bank, same antenna, same frequency.

The ATU functioning depends on the **memory banks** organization. For each bank **three sets of tuning data** are saved; one set for each antenna. A set of tuning data is nothing more than a list of tuning data organized relatively to **reference frequencies**. The number of tuning data (in other words the number of reference frequencies) depend on the step used according to the operating band :

- for 160m the step is 2kHz,
- for 80m the step is 4kHz,
- for 60m the step is 5kHz,
- for 40m the step is 5kHz,
- for 30m the step is 10kHz,
- for 20m the step is 10kHz,
- for 17m the step is 10kHz,
- for 15m the step is 20kHz,
- for 12m the step is 25kHz,
- for 10m the step is 25kHz,
- for 6m the step is 50kHz.

Some practical examples of what happens :

- start tune-up with **working frequency equal to 14.001MHz**, the tuning data is saved on the reference frequency 14.000MHz,
- start tune-up with **working frequency equal to 14.002MHz**, the previous tuning data on the reference frequency 14.000MHz is overwritten by the new value,
- start tune-up with **working frequency equal to 14.007MHz**, the tuning data is saved on the reference frequency 14.010MHz,
- the **working frequency becomes equal to 14.002MHz**, the tuning data of the reference frequency 14.000MHz is loaded,
- the **working frequency becomes equal to 14.009MHz**, the tuning data of the reference frequency 14.010MHz is loaded,
- the **working frequency becomes equal to 14.011MHz**, the tuning data of the reference frequency 14.010MHz is kept loaded,
- the **working frequency becomes equal to 14.016MHz**, no tuning data is loaded.

The DUO-ART 60 displays messages on the right of the display to provide information on the loaded and set tuning data. Messages can be :

- **Tune Data Loaded** : the tune-up has already been carried out and the data is in use, no tune-up is needed (if the connected antenna has not been changed),
- **No Tune Data Available** : no tuning data was found and no data is therefore in use, it is necessary to perform the tune-up,
- **Antenna Tuner Bypassed** : the tuner is in bypass, the bypass can be removed to check the tune-up status, i.e. "Loaded" or "Not Available".

To tune-up antennas follow the tune-up procedure in **Annex C - Tune-up Procedure**.

While the **Tune Menu** is displayed, it is possible to switch to the **Manual Tune Menu** with a normal press on the **MANUAL Tune** button.

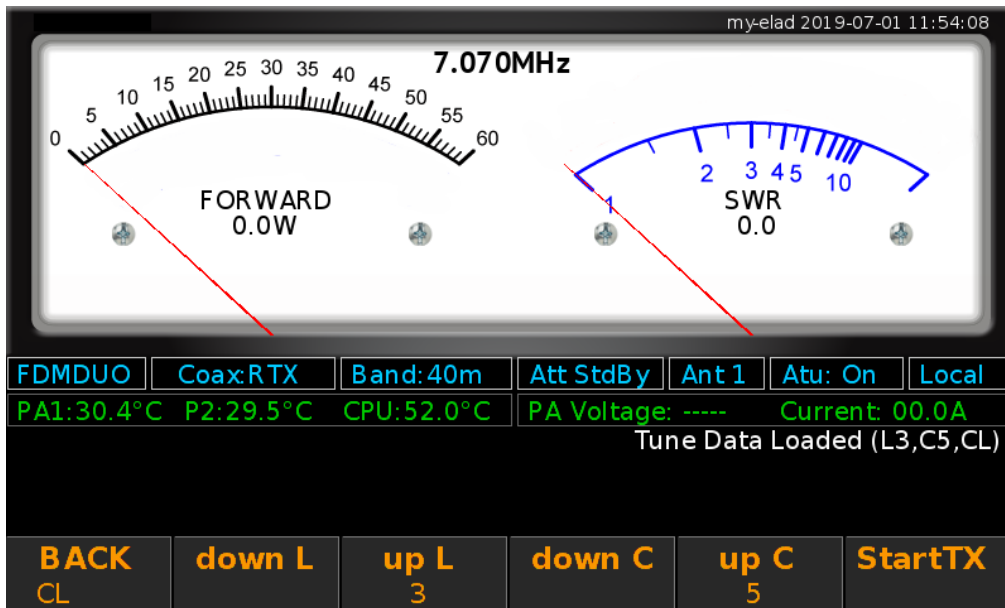

This menu allows you to manually adjust the various ATU parameters which are :

- the **ATU configuration** : by long pressing on the left button you can choose one of three configurations : **CL** (first capacitance and after inductance), **LC** (first inductance and after capacitance) and finally **ByPass**,
- the value of the inductance : the **down L** and **up L** buttons allow you to change the value,
- the capacity value : the **down C** and **up C** buttons allow you to change the value.

The **StartTX** button allows you to start the transmission in order to evaluate the effect of the current configuration on the SWR, during transmission the **StartTX** button becomes the **StopTX** button which is used to stop the transmission.

To save the manual tuning data you need to press the **BACK** button, the window changes and another menu is presented:



- the **ESC** button allows you to exit without saving,
- the **SAVE** button allows you to save the current state of the ATU as a tuning data,
- the **BANK** and **ANT** buttons allow you to modify the destination for saving the tuning data if necessary.

It is possible to proceed to a manual tune-up after performing an automatic tune-up to manually adjust the tuning data.

3.2.5 Setting Menu

While the **Main Window** is displayed, it is possible to enter to the **Setting Menu** with a normal press on the **SET** button.

The picture below shows how changes the **Main Window** while the **Setting Menu** is displayed.

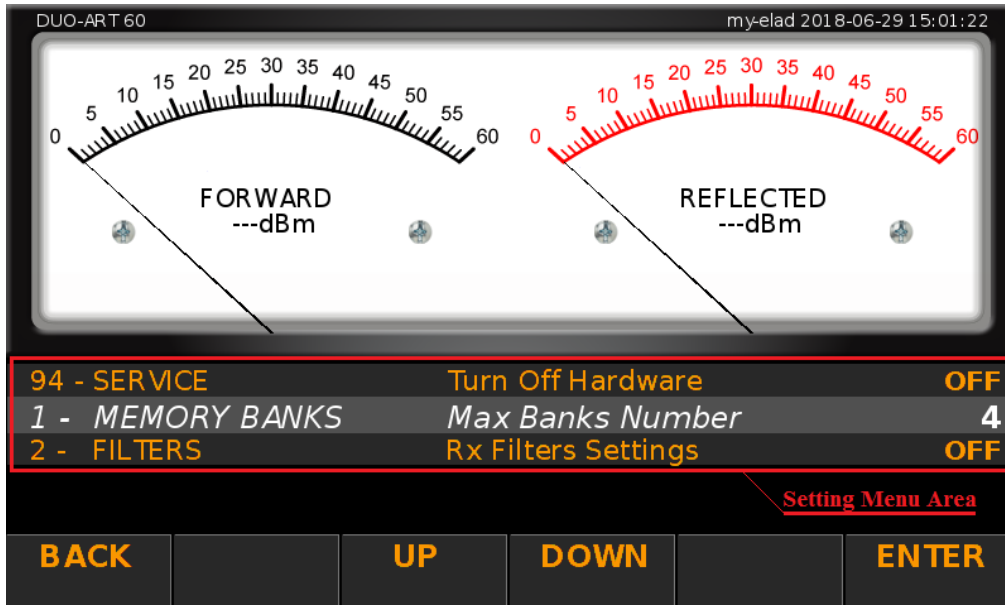

The **BACK** button allows to exit from the **Setting Menu**. The **UP** and **DOWN** buttons allow to navigate in the **Setting Menu**.

The **Setting Menu** is organized in four columns that are the **menu number**, the **menu group**, the **menu name** and the **current value visualization**.

Number	Group	Name	Current Value
24	TUNE	ATU Installed	Yes
30	MAIN WINDOW	Powers Unit	dBm
31	MAIN WINDOW	Temperatures Unit	Celsius

To modify the value of an menu, press the **ENTER** button, use the **-** and **+** button to modify the value and finally press **ENTER**.

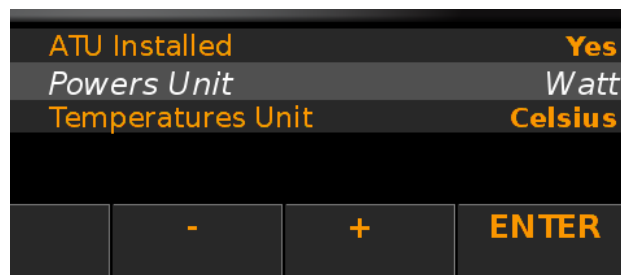

“Setting Menu” refers to the **Setting Menu** visualization, “menu” refers to the individual **menu items**.

The following table presents all the available **menu items**. It is organized in three section : **GENERAL**, **VISUALIZATION** and **ADVANCED**.

#	Menu Group	Menu Name	Menu Description	Values	Default
GENERAL SECTION					
1	MEMORY BANKS	Max Banks Number	Sets the number of memory banks to use	2 to 20	3
2	FILTERS	Reception Filters Setting	Allows to enable/disable the reception filters For details see the section Menu 2: Rx Filters Setting after this table	ON / OFF	-
5	MODALITY	Use Mode	Sets the DUO-ART modality	Local / Remote	Local
6	MODALITY	Remote Password	Allows to view the password and generate a new one	Exit / Generate	-
10	TIME	Long Press Time	Sets the time used to recognize a long press on the buttons	0.3 to 5.0 sec	0.5 sec
11	TIME	Screensaver Timeout	Specifies the screensaver timeout	5min / 10min / 20min / 30min / 60min	60min
15	PEAK POWER METER	Activation	Enables/disables the Peak Power Meter function on the Main Window	ON / OFF	OFF
16	PEAK POWER METER	Release Time	Sets the release time of the Peak Power Meter function	0 to 5000 ms, in 10ms steps	3000 ms
20	TUNE	Enable Tune	Enables/disables the tune functionality	ON / OFF	ON
21	TUNE	Force Attenuator	Force a different attenuator value during tuning	0dB / 2dB / 3dB / 5dB	5dB
22	TUNE	Target SWR (0=Off)	Sets the SWR value to be achieved during tuning Higher is the value shorter will be the tuning time	0 / 1.00 to 10.00 in 0.01 steps	0.00
23	TUNE	Auto Tune Timeout	Sets the Auto Tune timeout	5 to 25 seconds in 5sec steps	25sec
24	TUNE	ATU Installed	Specifies if ATU is installed or not	Yes / No	Yes
25	TUNE	Duo PttOut (menu 56)	Allows to manage the PTT output of the FDM-DUO during tuning	Force To No / Not Force	Force To No

#	Menu Group	Menu Name	Menu Description	Values	Default
VISUALIZATION SECTION					
30	MAIN WINDOW	Powers Unit	Specifies the unit used to display the powers on the Main Window	Watt / dBm	Watt
31	MAIN WINDOW	Temperatures Unit	Specifies the temperature unit to use in the Main Window	Celsius / Fahrenheit	Celsius
32	MAIN WINDOW	View on TX	Allows to display a different view during transmission	OFF / View 1 / View 2 / View 3 / View 4 / View 5	OFF
40	PLOT	Spectrum Settings	Allows to set for each band : - the reference level (Ref Lev); -300 to 100 dBm (default -110dBm) - the position of the reference (Ref Pos); 0 to 10 (default 0) - the number of dBm per division (Point Div); 1, 2, 5, 10 or 20 (default 10) - the offset value of the graph (Offset); -200 to 200 dBm (default 0dBm) For details see the section Menu 40: Spectrum Settings after this table	Exit / Modify	-
45	PLOT	Waterfall Enable	Enable or disable the display of the waterfall on views 4 and 5	ON / OFF	OFF
46	PLOT	Waterfall Position	Allows to choose where to display the waterfall relative to the spectrum	Top / Bottom	Bottom
47	PLOT	Waterfall Scroll	Allow to choose how the waterfall slides vertically, up or down	Up / Down	Up
48	PLOT	Waterfall Max dBm	Allows to set the upper limit of the waterfall display in dBm	-200 a 200 dBm	-40 dBm
49	PLOT	Waterfall Min dBm	Allows to set the lower waterfall display limit in dBm	-200 a 200 dBm	-140 dBm

#	Menu Group	Menu Name	Menu Description	Values	Default
ADVANCED SECTION					
50	LAN	IP	IP address setting	IP address example: 192.168.1.10	-
51	LAN	Subnet	Subnet setting	Subnet mask example:255.255.255.0	-
52	LAN	Gateway	Gateway setting	Default gateway example : 192.168.1.1	-
53	LAN	DNS	DNS setting	DNS server example : 8.8.8.8	-
60	TEMPERATURE	P1 Alarm Set Point	Alarm threshold for sensor temperature 1	20°C to max allowed	70 °C
61	TEMPERATURE	P2 Alarm Set Point	Alarm threshold for sensor temperature 2	20°C to max allowed	80 °C
65	FAN CONTROL	Work Mode	Allows to choose between two working modes: - Hi Perf: fan intensive use - SSB: fan reduced use	Hi Perf or SSB	Hi Perf
70	FREQ	Period	Frequency calculation period of the frequency meter	10 to 10000 ms, in 10ms steps	10 ms
90	SERVICE	Factory Default	Allows to reset the parameters to the factory default	No Default / Set Default	No Default
91	SERVICE	Remote Service	Enables remote connection for maintenance	ON / OFF	OFF
92	SERVICE	Software Update (UI)	Launches the software update (user interface)	ON / OFF	OFF
93	SERVICE	Firmware Update	Enables the firmware update (internal circuitry)	ON / OFF	OFF
94	SERVICE	Turn off Hardware	Allows to shut down the hardware	ON / OFF	OFF

❖ **Menu 2 : Rx Filters Setting.**

Choosing **Modify** in menu **2 Rx Filters Setting** gives access to a window that presents the list of settings for the reception filters, also called preselectors. These preselectors correspond to the **Preselector Filters** part of the block diagram of section **1.5 Block Diagram**.

N	Start (Hz)	Stop(Hz)	Enabled
1	10000	1000000	On
2	1800000	2000000	On
3	2500000	4000000	On
4	7000000	7200000	On
5	10000000	10350000	On
6	14000000	14350000	On
7	18000000	18200000	On
8	50000000	56000000	On

my-elad 2019-06-27 15:22:44

ESC UP DOWN ENTER

Pressing the **ENTER** button after selecting the filter using the **UP** and **DOWN** buttons gives access to another window that allows to change the frequency limits for activating the eight filters present in the DUO-ART 60. It is also possible to deactivate and reactivate every single filter.

N	Start (Hz)	Stop(Hz)	Enabled
1	10000	1000000	On
2	1800000	2000000	On
3	2500000	4000000	On
4	7000000	7200000	On
5	10000000	10350000	On
6	14000000	14350000	On
7	18000000	18200000	On
8	50000000	56000000	On

my-elad 2019-06-27 15:24:03

BACK NEXT STEP 10kHz - + SAVE

The **NEXT** button allows to change the selected field which is indicated in red. The **STEP** button allows to choose the step with which to change the frequency values with the **-** and **+** buttons. The **SAVE** button allows to save the changes made.

After setting the frequency limits for each reception filter, the corresponding filter must be inserted in the related slot. To do this, first remove the cover of the DUO-ART 60 by following these instructions :

- turn off the DUO-ART 60 and disconnect all cables,
- turn the DUO-ART 60 upside down,
- remove the four cover fixing screws, as shown in the image below,
- turn the DUO-ART 60 over and remove the cover.

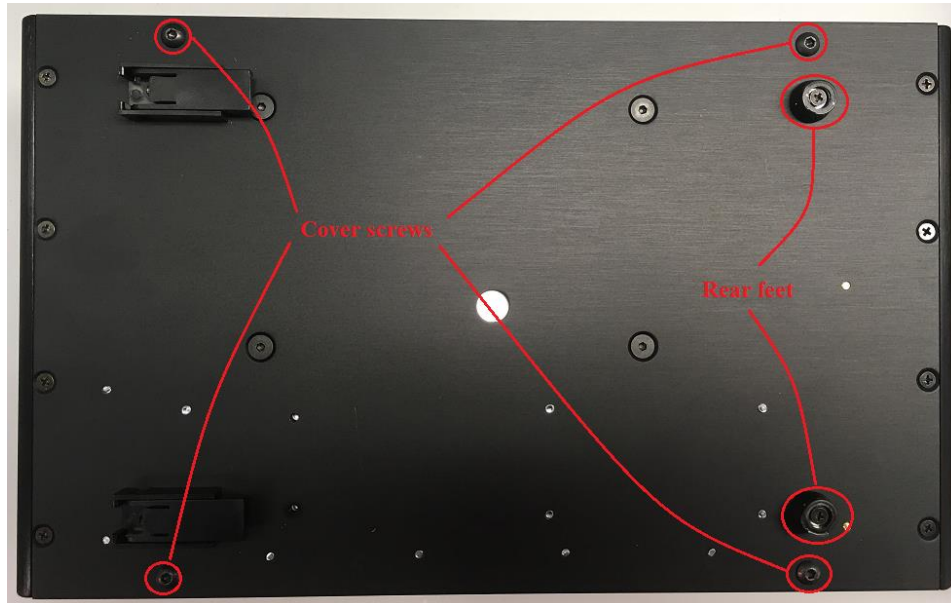

The image below indicates the number of the reception filter slots, relatively to what is written on the **FILTER SETTINGS** screen.

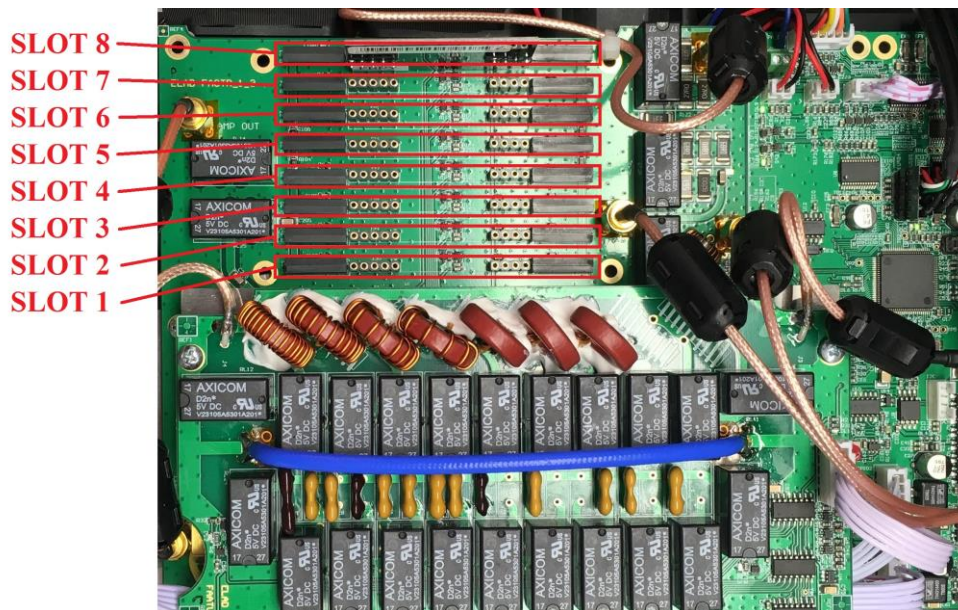

Once the reception filters are inserted in their slots, close the DUO-ART 60.

❖ **Menu 40 : Spectrum Settings.**

Choosing **Modify** in menu **40 Spectrum Settings** gives access to a window that shows the different spectrum settings for each amateur band :

- **Offset** : is the offset value of the graph, settable values are from -200dBm to + 200dBm, the default value is 0dBm,
- **Lev** : is the reference level, settable values are from -300dBm to + 100dBm, the default value is -110dBm,
- **Pos** : is the position of the reference, settable values are from 0 to 10, the default value is 0,
- **Div** : is the number of dBm per division, settable values are 1, 2, 5, 10 or 20, the default value is 10.

The **SET Default** button allows to set the default values for all settings. The **TYPE** button (with the choices **Single** or **All**) allows to choose whether to change the settings "row by row" (i.e. for each amateur band) or then to change the settings for all amateur bands.

my-elad 2019-06-27 15:26:18

SPECTRUM SETTING

Config Type	Single (Set different values for each band)			
Band	Offset(dBm)	Lev(dBm)	Pos	Div
160m	1	-70	10	5
80m	1	-70	10	5
60m	1	-70	10	5
40m	1	-70	10	5
30m	1	-70	10	5
20m	1	-70	10	5
17m	1	-70	10	5
15m	1	-70	10	5
12m	1	-70	10	5
10m	1	-70	10	5
6m	1	-70	10	5
Other	1	-70	10	5

ESC	SET Default	UP	DOWN	TYPE Single	ENTER
------------	-----------------------	-----------	-------------	-----------------------	--------------

To choose the row (or amateur band) to be modified, use the **UP** and **DOWN** buttons, then press the **ENTER** button to go to the next window which allows to change the various settings.

This window allows to change the various spectrum settings.

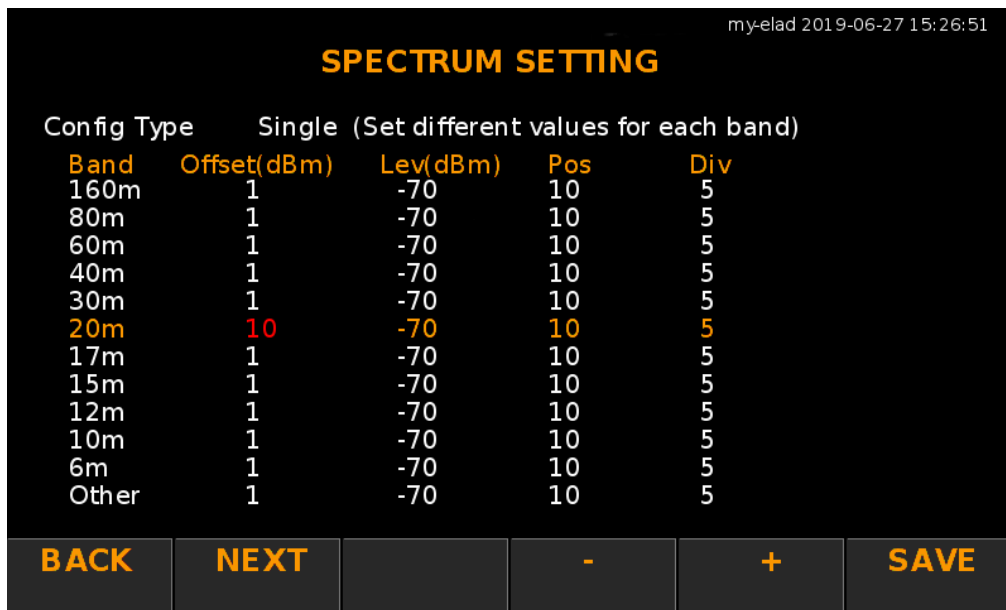

The **NEXT** button allows to change the selected field which is indicated in red. The **-** and **+** buttons allow to change the value of the selected field. The **SAVE** button allows to save the changes made.

3.2.6 Messages

This section provides the list of messages that can be viewed on the DUO-ART 60 amplifier display. There are two types of messages : **warning** and **error**. They are displayed in the lower right corner of the display. The image below shows the position of the **message** and which button to press to reset the warning or error. More than one message may appear in the same time on the display. It is necessary to reset the messages with the reset button before using again the DUO-ART 60 amplifier.

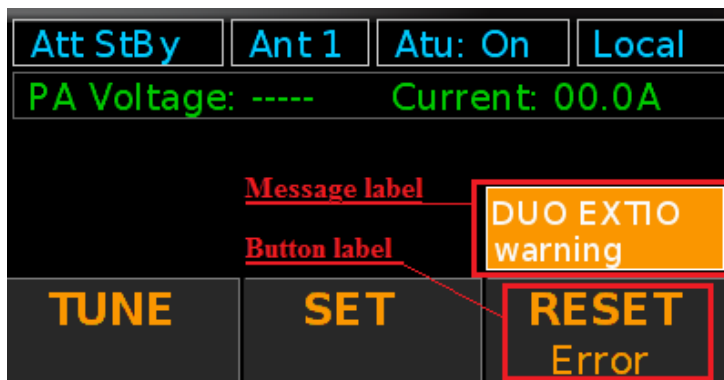

The following table provides the list of all messages with their description.

Name	Type	Code	Description
No LAN warning	Warning	W-100	-
Web socket warning	Warning	W-101	-
Audio not found	Warning	W-115	The DUO-ART 60 cannot find the sound card of the FDM-DUO. This warning is only displayed if the REMOTE mode is active.
Audio read warning	Warning	W-116	Problem with receiving audio coming from the FDM-DUO. This warning is only displayed if the REMOTE mode is active.
Audio write warning	Warning	W-117	Problem of audio transmission to the FDM-DUO. This warning is only displayed if the REMOTE mode is active.
DUO mode not activated	Warning	W-130	The DUO-ART 60 is in REMOTE mode but the active interface is not FDM-DUO.
DUO EXTIO warning	Warning	W-131	Reporting a communication problem between the DUO-ART 60 and the FDM-DUO.

Name	Type	Code	Description
Comm warn	Warning	W-145	Indicates an internal communication problem. After "warn" a code composed of alphanumeric characters is added.
Micro Reset warning	Warning	W-146	Indicates an internal problem of the operation of the DUO-ART 60. This problem resolves automatically. <i>Warning code: ST-P10-b3.</i>
CMD not available	Warning	W-147	Indicates the inability to perform an internal operation.
Band warn StBy	Warning	W-148	Automatic activation of the stand-by following an unauthorized transmission. <i>Warning code: ST-P10-b2.</i>
Auto Tune timeout	Warning	W-160	This warning appears when the maximum time available for automatic tuning of the antenna expires. This time can be set from the "AutoTune Timeout" menu.
Auto Tune SWR warning	Warning	W-161	This warning appears if the target SWR has not been reached after the time-out has been set. This warning is only displayed if the "Target SWR" menu is set to a value other than 0.
Auto Tune DUO aborts	Warning	W-162	The FDM-DUO has left the tuning mode (Tune) before the DUO-ART 60. This warning is displayed if the tuning mode of the FDM-DUO times out or if the FDM-DUO detects a high SWR.
Auto Tune Max SWR	Warning	W-163	This warning appears if the DUO-ART 60 has found a tuning point but the calculated SWR is too high.
Auto Tune Low Pwr	Warning	W-164	This warning appears if the DUO-ART 60 cannot initiate the tune procedure because the input power is too low.
High temperature	Warning	W-175	High temperature warning.
High temperature	Error	E-400	Maximum temperature exceeded. This error cannot be reset. It is necessary to wait for the temperature to decrease before use the DUO-ART 60 amplifier again.
HI SWR error	Error	E-410	Error generated by a too high SWR. This is a hardware protection. <i>Error code: ST-P2-b1.</i>
Error I OUT	Error	E-420	The current absorbed by the DUO-ART 60 has exceeded the maximum threshold. <i>Error code: ST-P9-b0.</i>

Name	Type	Code	Description
Error REFL	Error	E-421	The calculated reflected power has exceeded the maximum threshold. <i>Error code: ST-P9-b1.</i>
Error FWD	Error	E-422	The calculated forward power has exceeded the maximum threshold. <i>Error code: ST-P9-b2.</i>
Error SENS PW	Error	E-423	The input power of the DUO-ART 60 has exceeded the maximum threshold. <i>Error code: ST-P9-b3.</i>
Error FILTER TX	Error	E-440	Set filter selection error. This error is generally due to an incorrect frequency setting. <i>Error code: ST-P10-b0.</i>
PWR IN error	Error	E-441	Error regarding the input power of the amplifier. The input power may be too high or the PTT input may not be connected properly. <i>Error code: ST-P10-b1.</i>

Messages are not shown if the **Memory Bank Window** or the **Information Window** is displayed.

3.3 Memory Bank Window

When the **Main Window** is displayed, doing a long press on the **MEM** button opens the **Memory Bank Window** that contains all the settings which can be personalized for the selected banks.

Before to open the **Memory Bank Window** from the **Main Window**, check the selected bank number.

For example : if the button label shows **BANK3** the **Memory Bank Window** will show the bank 3 settings.

Below is an example of the **Memory Bank Window**.

my-elad 2019-06-28 13:38:43

Memory Table Bank 1 - Interface: FDMDUO

N	Band	PwrIn	Att(dB)	AmpEnable	Ant	Atu
1	160m	3.0	3	On	1	On
2	80m	3.0	3	On	1	On
3	60m	4.0	3	On	2	On
4	40m	5.0	0	On	2	Off
5	30m	---	---	Off (StdBy)	1	Off
6	20m	2.0	0	On	3	Off
7	17m	---	---	Off (StdBy)	1	Off
8	15m	---	---	Off (StdBy)	1	Off
9	12m	---	---	Off (StdBy)	1	Off
10	10m	4.6	5	On	3	On
11	6m	5.0	2	On	3	On

Buttons: BACK (PWROFF), INTERF (FDMDUO), UP, DOWN, UTIL, ENTER

Callouts: Selected Interface (FDMDUO), Selected Bank (Bank 1), DUO-ART Settings (Table), FDM-DUO Power (PwrIn)

On the top of the **Memory Bank Window**, the number of the **selected bank** and the **associated interface** are shown. The center area of the window regroups the **bands settings**, for each band it is possible to set :

- **PwrIn** : the transmission power of the FDM-DUO (available only with the FDMDUO interface),
- **Att** : the attenuators value (0dB, 2dB, 3dB o 5dB) located before the PA (power amplifier),
- **AmpEnable** : the internal power amplifier (PA) state, which can be **On** or **Off (StdBy)**,
- **Ant** : the selected antenna to transmit,
- **Atu** : the enable state of the antenna tuner (ATU).

AmpEnable equal to **Off (StdBy)** corresponds to the **Stand-By** mode activated.

These settings can be found :

- in the **Main Window** where there are settings **Att** and **AmpEnable** (IN-ATT) and **Ant** (ANT):

MEM BANK1	IN-ATT StdBy	ANT 3	TUNE	SET	VIEW 1
MEM BANK1	IN-ATT 0dB	ANT 3	TUNE	SET	VIEW 1

- in the **Tune Menu** where there is the setting **Atu** (ATU) :

BACK	TUNE F Off	TUNE Off	ATU On	MANUAL Tune
-------------	----------------------	--------------------	------------------	-----------------------

DUO-ART 60 settings present in the **Memory Bank Window** are updated if modified from the **Main Window** (**Att**, **AmpEnable** and **Ant**) or from the **Tune Menu** (**Atu**), this is true for the band currently in use.

The **INTERF** button allows to choose the selected interface for the current memory bank. The **UP** and **DOWN** buttons allow to select a band, once selected press on the **ENTER** button to modify the band settings.

my-elad 2019-06-28 13:38:43

Memory Table Bank 1 - Interface: FDMDUO

N	Band	PwrIn	Att(dB)	AmpEnable	Ant	Atu
1	160m	3.0	3	On	1	On
2	80m	3.0	3	On	1	On
3	60m	4.0	3	On	2	On
4	40m	5.0	0	On	2	Off
5	30m	---	---	Off (StdBy)	1	Off
6	20m	2.0	0	On	3	Off
7	17m	---	---	Off (StdBy)	1	Off
8	15m	---	---	Off (StdBy)	1	Off
9	12m	---	---	Off (StdBy)	1	Off
10	10m	4.6	5	On	3	On
11	6m	5.0	2	On	3	On

BACK PWROFF	INTERF FDMDUO	UP	DOWN	UTIL	ENTER
-----------------------	-------------------------	-----------	-------------	-------------	--------------

The **UTIL** button allows to access to the utilities functions (copy bank, reset bank, ...).

A long press on the **PWROFF** button allows to power off the DUO-ART 60.

The settings change window is as below. < and > keys allow you to change the selected field which is indicated in red. - and + keys allow you to change the value of the selected field. The **SAVE** key allows you to save the changes made.

my-elad 2019-06-28 13:39:31

Memory Table Bank 1 - Interface: FDMDUO

N	Band	PwrIn	Att(dB)	AmpEnable	Ant	Atu
1	160m	3.0	3	On	1	On
2	80m	3.0	3	On	1	On
3	60m	4.0	3	On	2	On
4	40m	5.0	0	On	2	Off
5	30m	---	---	Off (StdBy)	1	Off
6	20m	2.0	0	On	3	Off
7	17m	---	---	Off (StdBy)	1	Off
8	15m	---	---	Off (StdBy)	1	Off
9	12m	---	---	Off (StdBy)	1	Off
10	10m	4.6	5	On	3	On
11	6m	4.7	2	On	3	On

BACK
<
>
-
+
SAVE

3.4 Information Window

When the **Main Window** is displayed, doing a long press on the **VIEW** button opens the **Information Window** which displays some information about the DUO-ART 60 amplifier.

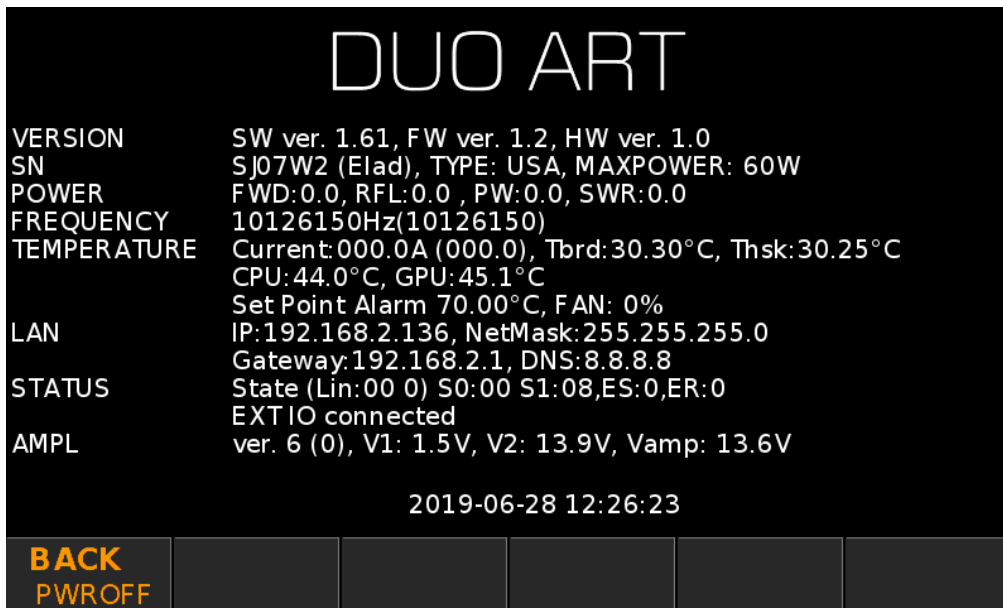

You can check here the **software and firmware versions**, as well as the current **IP address**.

A long press on the **PWROFF** button allows to power off the DUO-ART 60.

Annex A - Technical Specifications

AC Power Supply	100 – 240 Vac 50/60Hz 2.3A (115V) 1.2A (230V)
DC Power Supply	13.8 Vdc (12 – 14 Vdc) Max 13A (no Aux DcOut) Max 15A (2.2A Aux DcOut)
Frequency Range	1.8 – 30 MHz, 50 – 54 MHz Not allowed 26 – 28 MHz (USA version)
Optimized Frequency Band	160m -> 1.800 – 2.000 MHz 80m -> 3.500 – 4.000 MHz 60m -> 5.3305 – 5.4035 MHz 40m -> 7.000 – 7.300 MHz 30m -> 10.100 – 10.150 MHz 20m -> 14.000 – 14.350 MHz 17m -> 18.068 – 18.168 MHz 15m -> 21.000 – 21.450 MHz 12m -> 24.890 – 24.990 MHz 10m -> 28.000 – 29.700 MHz 6m -> 50.000 – 54.000 MHz
Input Power	Typical 4W for 60W output (HF) 10W maximum
Power Gain	Less than 15 dB, 13dB typical
Output Power	60W with 5W input (HF band) 50W with 5W input (6m band)
Output Harmonic / Spurious Distortion	> 50 dBc in HF band typical 60 dBc > 65 dBc in 6m band typical 68 dBc
Metering	Input Power Output Power VSWR Drain Current Drain Voltage Temperature

ATU Impedance Matching Range	<p>≈ 6 to 1k ohms (HF band) ≈ 16 to 150 ohms (6m band)</p>
Ports	<p>RTX Connector (SO239) RX Connector (SO239) Antenna Connector 1 (SO239) Antenna Connector 2 (SO239) Antenna Connector 3 (SO239) Ground Connector</p> <p>PTT Input Connector (jack 3.5 mm) PTT Output Connector (jack 3.5 mm) EXT IO1 Connector EXT IO2 Connector RS233 Connector USB Connector (AUX) LAN Connector USB host1 USB host2</p> <p>AC Power In Connector DC IN Connector (Powerpole) DC OUT Connector (Powerpole)</p>
Dimensions (H x W x L)	<p>1100 mm x 1800 mm x 2750 mm 4,3 in x 7,1 in x 10,8 in</p>
Weight	<p>3,5 Kg 7,7 lb</p>

Annex B - DUO-ART 60 Connections

FDMDUO Interface - Local Setup

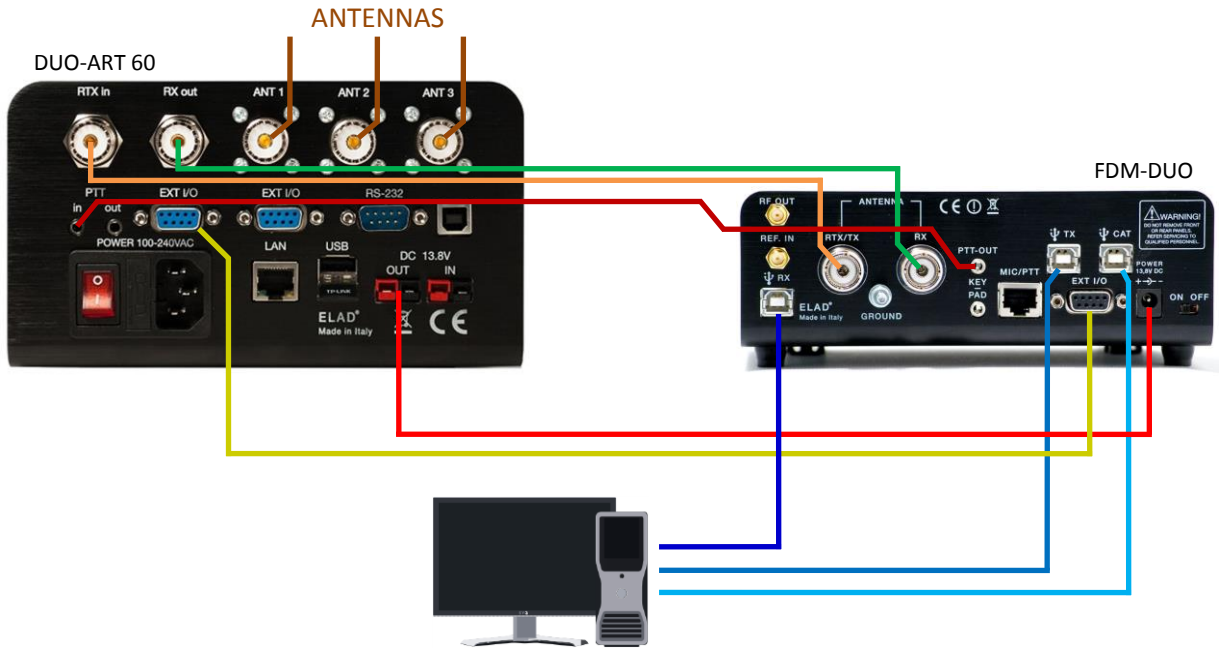

FDMDUO Interface - Remote Setup

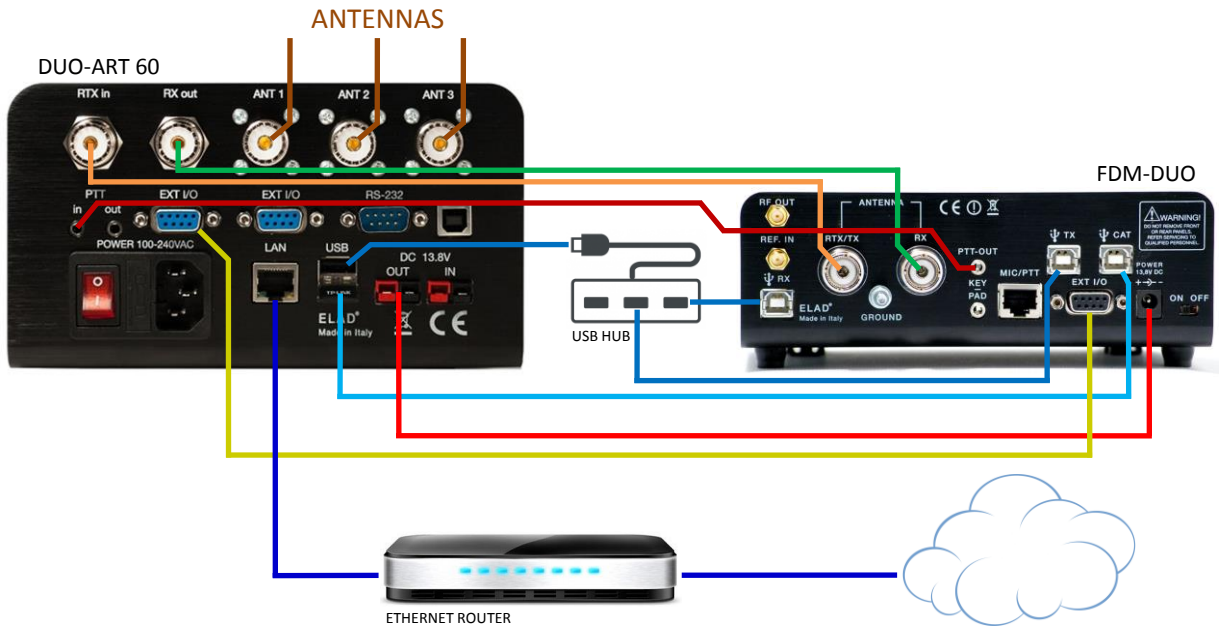

Generic Interface

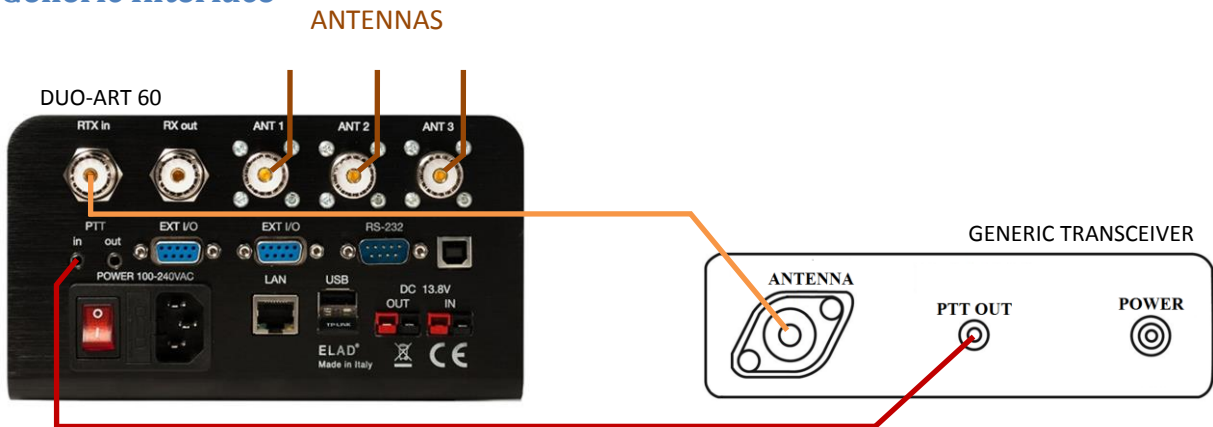

FT-817 Interface

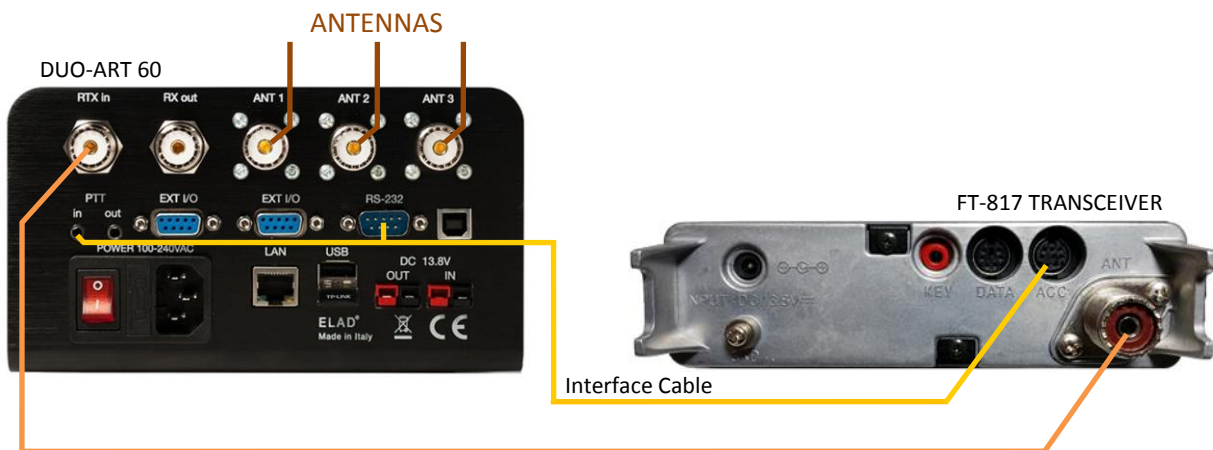

Interface Cable Diagram

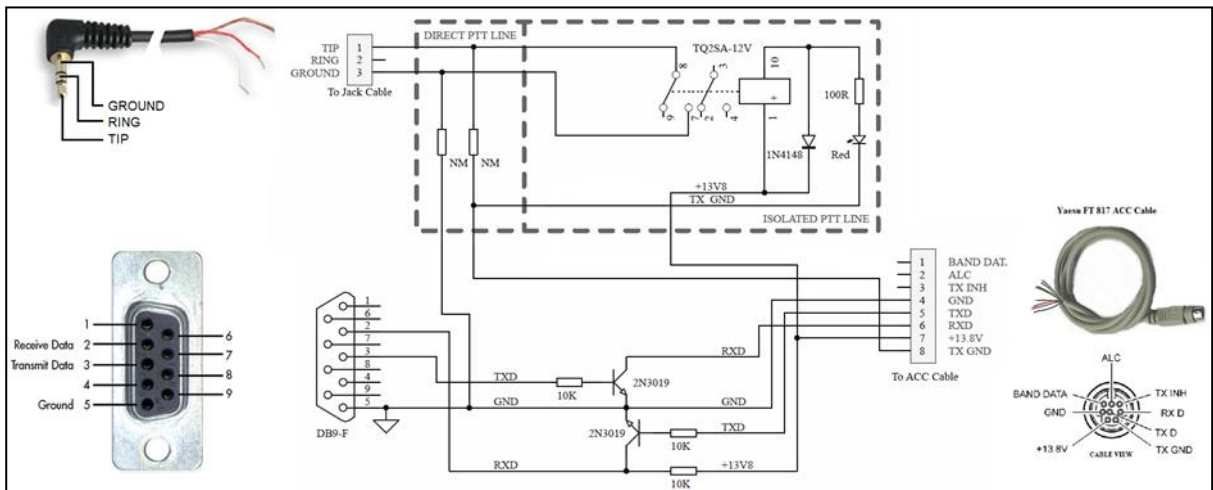

Annex C - Tune-up Procedure

Foreword

To ensure maximum efficiency and RF output power it is important to have a good match from power amplifier and antenna, the DUO-ART 60 is made to match nominally resistive 50 Ohm impedance.

DUO-ART 60 can have the **automatic antenna tuner unit (ATU)** installed. The ATU is an hardware option and can handle load mismatches.

When no ATU is installed there is no tune-up procedure because the DUO-ART 60 is factory aligned for 50Ohm load, and allow to operate with a VSWR inferior to 2 at maximum power. The DUO-ART 60 safety conditions correspond to have 6W maximum of reflected power otherwise the DUO-ART 60 switches in **Stand-By** mode automatically (no gain).

When the ATU is installed, before operating in transmission it is recommended to make the tune procedure for all antennas, bands and sub-bands. Tuning data are stored in memory bank, so when the tune procedure is done data of ATU settings are automatically recalled based on the selected antenna and the operating frequency. The DUO-ART 60 can save and manage up to 20 different **Memory Banks**.

Warning

It is possible to bypass the DUO-ART 60 internal tuner and use an external tuner but it is mandatory to exclude the internal one. **Never use the internal tuner with an external tuner this can cause damaging in DUO-ART 60.**

With the FDM-DUO Transceiver

When the DUO-ART 60 is connected to the FDM-DUO transceiver (with RTX coax cable, PTT jack cable, EXT I/O flat cable and DC power cable), it is **highly recommended** to have this settings :

- DUO-ART 60 Interface selected : FDMDUO,
- FDM-DUO menu 49 TUNE TIME : 60 seconds,
- FDM-DUO menu 55 TUNE PWR : 5 watt,
- FDM-DUO menu 56 TUNE PTT : no.

These settings allow to make tuning without powering the PA, consequently the ATU is used safely, with low power.

The tune-up procedure can be starting from both the FDM-DUO and the DUO-ART 60.

To start the procedure from the FDM-DUO :

- enter to the **Tune Menu** of the DUO-ART 60 and set the ATU to ON,
- press the **F3** button on the FDM-DUO and the DUO-ART 60 will start the **automatic tune-up**.

The tune-up procedure can be starting from both the FDM-DUO and the DUO-ART 60. To start the procedure from the DUO-ART 60 :

- enter to the **Tune Menu** of the DUO-ART 60 and set the ATU to ON,
- press the **TUNE** button to start the **automatic tune-up**.

If tune-up operation ends correctly (no **Messages**), data of the optimal matching are saved in the selected bank. If needed, it is possible to proceed to a **manual tune-up** accessing to the **MANUAL Tune menu** where inductance and capacitance can be adjusted manually.

With a Generic Transceiver

When the DUO-ART 60 is connected to a generic transceiver the frequency counter detects the operating band and sub-band. To make the right tuning with the DUO-ART 60 ATU follow these steps:

- set the output power of the transceiver at about 1W,
- set the transceiver to transmit a continuous tone (CW or FM),
- set the attenuators of the DUO-ART 60 at 0dB,
- enter to the **Tune Menu** of the DUO-ART 60 and set the ATU to ON,
- then, assert the PTT input of the DUO-ART 60,
- next, in the **Tune Menu** press the **TUNE** button to start the **automatic tune-up**.

If tune-up operation ends correctly (no **Messages**), data of the optimal matching are saved in the selected bank. If needed, it is possible to proceed to a **manual tune-up** accessing to the **MANUAL Tune menu** where inductance and capacitance can be adjusted manually.

Product Warranty

ELAD S.r.l. warrants the DUO-ART 60 for a period of 2 years inside Europe, and for a period of 1 year outside Europe unless otherwise specified. Warranty begins from the purchase date. All DUO-ART 60 will be repaired or replaced due to malfunction resulting from no fault of the end user. This warranty covers normal intended usage of the product and does not cover misuse, abuse, accidents, viruses, unauthorized service parts or the combination of other unauthorized branded products used in conjunction with the DUO-ART 60.

Declaration of Conformity (EC)

The product marked as

DUO-ART 60

manufactured by

Manufacturer: ELAD S.r.l.
Address: Via Col De Rust, 11 - Sarone
33070 CANEVA (PN)

is produced in conformity to the requirements contained in the following EC directives:

- RED Directive 2014/53/CE
- EMC Directive 2004/108/CE
- Low Voltage Directive 2006/95/CE
- RoHS Directive 2011/65/CE

The product conforms to the following Product Specifications:

Emissions & Immunity:

ETSI EN 301 489-1 V1.9.2
ETSI EN 301 489-15 V1.2.1
ETSI EN 301 783-2 V1.2.1

Safety:

EN 60950-1:2006 + A11:2009 + A1:2010 + A12:2011 + A2:2013

And further amendments.

This declaration is under responsibility of the manufacturer:

ELAD S.r.l.
Via Col De Rust, 11 - Sarone
33070 CANEVA (PN)

Issued by:

Name: Franco Milan
Function: President of ELAD

Caneva
Place

February, 28th 2018
Date

Signature

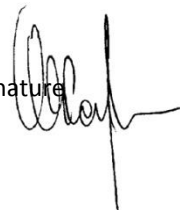

FCC Certification

TCB

TCB

**GRANT OF EQUIPMENT
AUTHORIZATION**

Certification
Issued Under the Authority of the
Federal Communications Commission
By:

EMCCert Dr. Rasek GmbH
Stoernhofer Berg 15
91364 Unterleinleiter,
Germany

Date of Grant: 04/26/2018
Application Dated: 04/26/2018

ELAD srl
via col de rust, 11
CANEVA, 33070
Italy

Attention: FRANCO MILAN

NOT TRANSFERABLE

EQUIPMENT AUTHORIZATION is hereby issued to the named GRANTEE, and is VALID ONLY for the equipment identified hereon for use under the Commission's Rules and Regulations listed below.

FCC IDENTIFIER: 2AAE5ART60
Name of Grantee: ELAD srl
Equipment Class: Amplifier
Notes: ELAD DUO ART 60W HF + 6m AMPLIFIER

<u>Grant Notes</u>	<u>FCC Rule Parts</u>	<u>Frequency Range (MHZ)</u>	<u>Output Watts</u>	<u>Frequency Tolerance</u>	<u>Emission Designator</u>
	97	1.8 - 29.7	60.0		XXX
	97	50.0 - 54.0	50.0		XXX

XXX - Emissions per 97.305 Amateur bands only

